

Y87JOS02XX Series Standard

Slide ABS hand shower holder.

Mounting hardware not required.

Product Data

Overall Dimensions (Inch.)	4-5/8 x 3-1/16 x 1-3/4
Net Weight (lbs.)	0.2





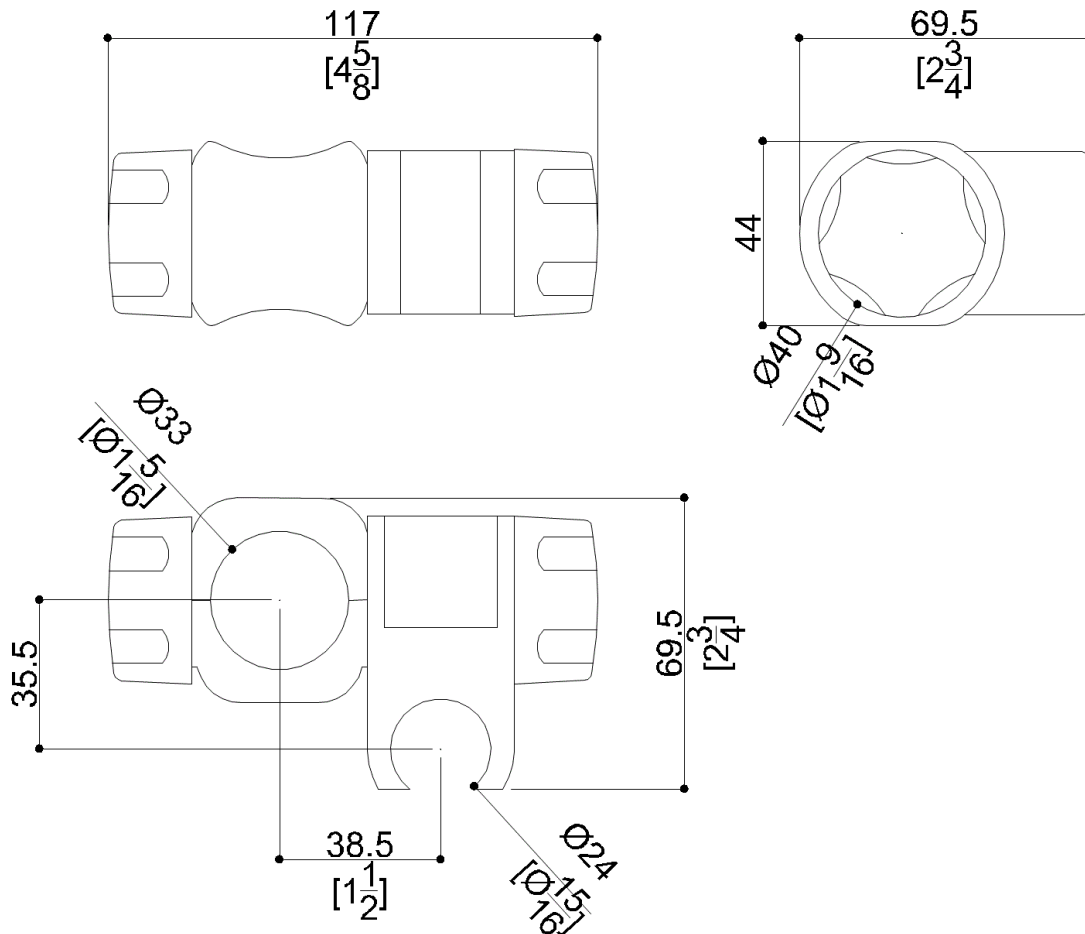











Packaging Details

Package	Polyethylene package
Package dimensions (Inch.)	4-7/8 x 3-1/8 x 2-3/16
Weight with Packaging (lbs.)	0.22



Y87JOS02XX Series Standard

Available Finishes (xx)

B1  Blue	B2  Light blue	C1  Chrome
D1  Black	D2  Greystone	D4  Dark Gray
G1  Green	G2  Light Green	I1  Ivory
I2  Biscuit	P4  Prune	R1  Vivid Red
R7  Ruby red	W1  White	Y1  Yellow Sun
Y3  Light Yellow		

Warning

Before installation and use, read the installation and use instructions in their entirety. If questions arise please contact Ponte Giulio company.

Cleaning

Product can be cleaned with a cloth and warm soapy water. Non abrasive, solvent free cleaners can also be used.

Warranty

Please visit www.pontegiulio.com for complete warranty details.

Materials and finishes

Polyamide Polished