

F17AKN04XX Series Nylon

Nylon robe hook with two hooks

Mounting hardware supplied for wood stud installation.

Product Data

Overall Dimensions (Inch.)	2-11/16 x 1-11/16 x 1-9/16
Net Weight (lbs.)	0.04

Installation Hardware Details

Stainless steel screw and dowels	Fischer SX6 4x38 Inox
----------------------------------	-----------------------

Packaging Details

Package	Cardboard package
Package dimensions (Inch.)	5-1/8 x 2-13/16 x 1-11/16
Weight with Packaging (lbs.)	0.15

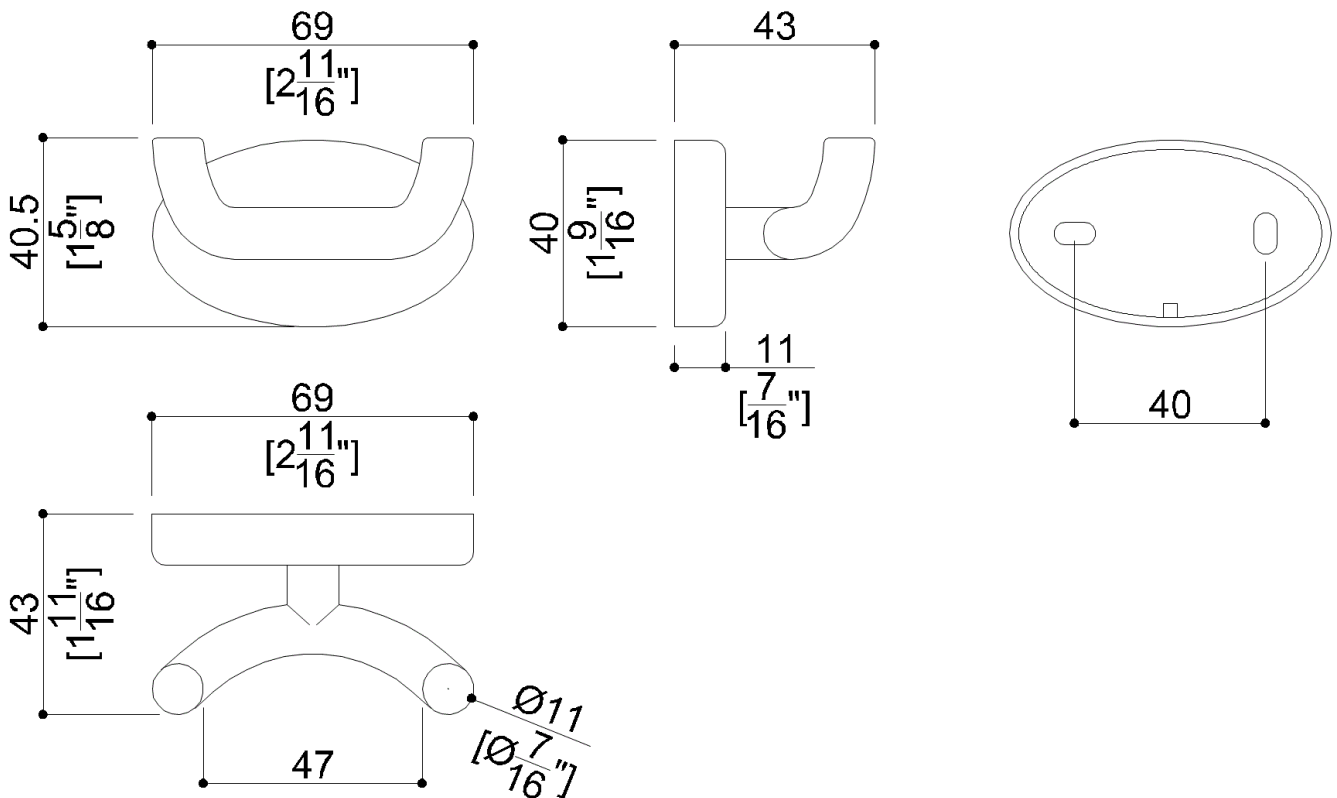





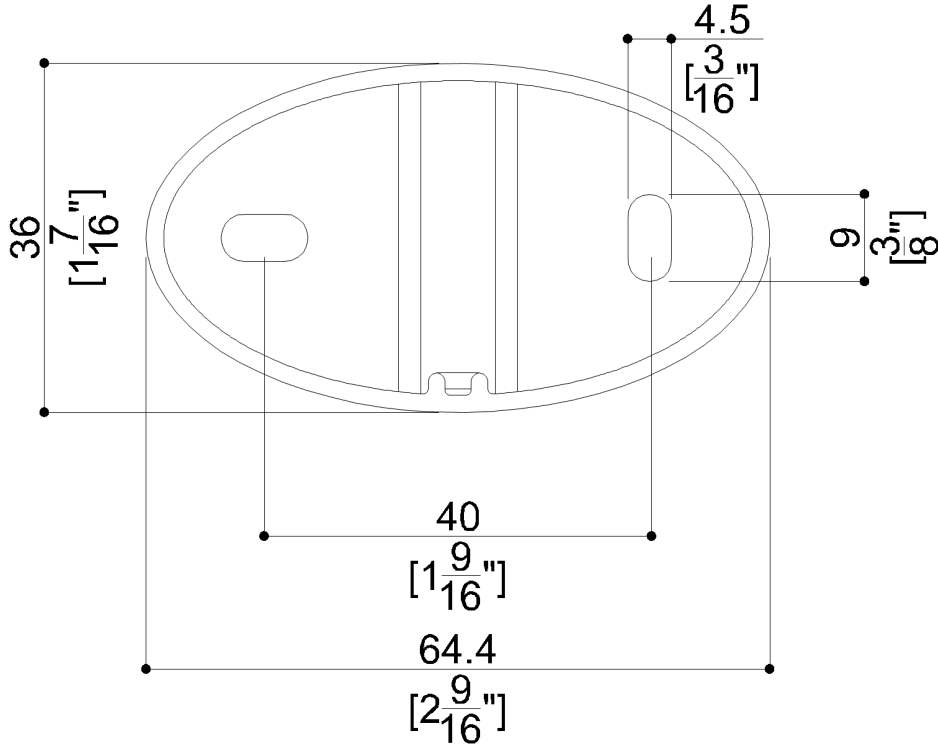









F17AKN04XX Series Nylon

Nylon fixing flange



Available Finishes (xx)

B1  Blue	B2  Light blue	D1  Black
D2  Greystone	D4  Dark Gray	G1  Green
G2  Light Green	I1  Ivory	I2  Biscuit
P4  Prune	R1  Vivid Red	R7  Ruby red
W1  White	Y1  Yellow Sun	Y3  Light Yellow

Load Capacity

Vertical 22 lbs.

Warning

Before installation and use, read the installation and use instructions in their entirety. If questions arise please contact Ponte Giulio company.

Cleaning

Product can be cleaned with a cloth and warm soapy water. Non abrasive, solvent free cleaners can also be used.

Warranty

Please visit www.pontegiulio.com for complete warranty details.

Materials and finishes

Polyamide Polished