

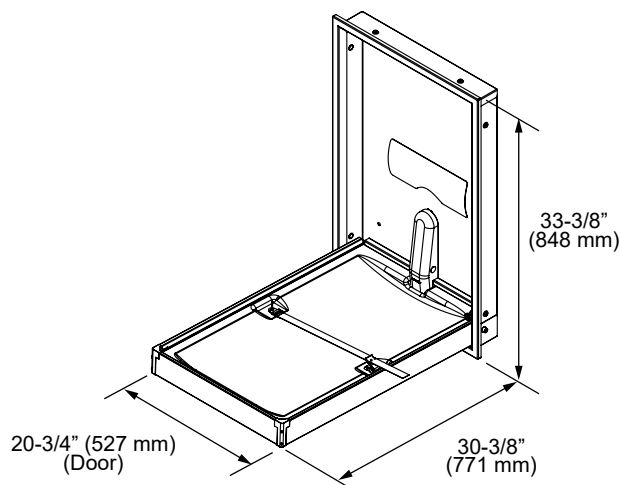

BABY CHANGERS MADE BY BABY EXPERTS.™



Submittal Sheet

Model 100SSV-R Vertical Stainless Steel Diaper Changing Station

- Full body 16 gauge, 304 brushed stainless steel.
- ABS replaceable tray liner.
- Full stainless steel frame and hinges provide maximum durability.
- Easy to read ANSI compliant labels (ANSI Z535.3 and ANSI Z535.4), utilizing universal safety symbols.
- Pneumatic gas shock mechanism to ensure smooth, safe open and close motions.
- Includes universal changing station door sign.
- Universal changing station plaque on front of unit.
- Limited Warranty: This product is warranted against manufacturing defects for a period of 5 years.

Recommended Blocking Recessed Mount

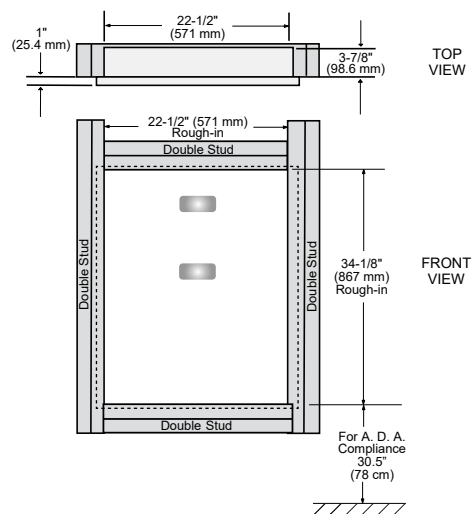

Short Specifications

Full 304 brushed stainless steel exterior with vacuum formed ABS changing surface.

1. A.D.A Compliant attached buckle.
2. Acceptable product: Foundations Worldwide, Inc.; Model 100SSV-R (Vertical Recessed Mount).
3. Characteristics:
 - a. Entire body 16 gauge, 304 brushed stainless steel, seamless welds.
 - b. Provide Foundations Worldwide, Inc. SS-Flange in order to surface mount unit.
 - c. Provide Foundations Worldwide, Inc. 200-SSLD; stainless steel liner dispenser.
4. Equipped with a pneumatic cylinder.
5. Smooth nylon belt with Thermoplastic Polyurethane coating. Easy to sanitize and adjustable with one hand.
6. Meets ASTM F2285 requirements for weight bearing Commercial Changing Stations.
7. **A.D.A. Compliance:**
 - 306.3 Knee clearance.
 - 307.2 Maximum protruding objects.
 - 308.2 Forward reach.
 - 308.3 Side reach.
 - 309.4 Operation.
 - 902.3 Work surface.
8. ANSI compliant safety labels.
9. CPSIA compliant to applicable sections.



Installation Information

- 3.88 inches (98 mm) recessed into wall, 1 inch (25 mm) protrusion from wall.
- Rough-in opening 34.125 inches (867 mm) wide x 22.50 (571 mm) high. Shim as required for tight fit on all 4 sides. Use side mounting holes.
- Open unit project from wall 30.375 inches (771 mm).